

Water Specialist EE Control Valve Programming and Cover Drawing Manual

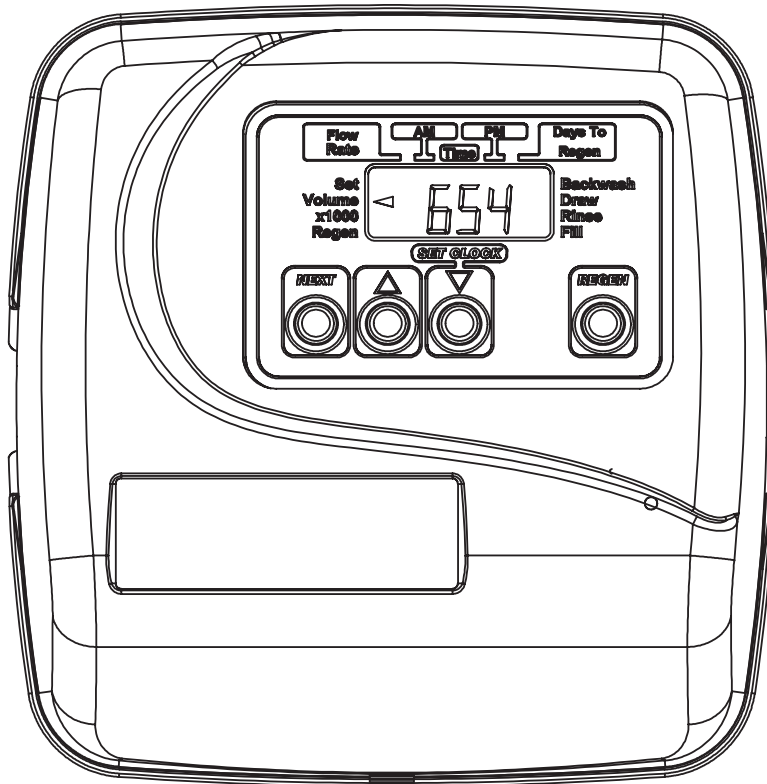

Table of Contents

- EE Front Cover and Drive Assembly..... 4
- Regeneration and Error Screens, Button Operations and Functions..... 5
- User Displays 6
- Configuration Settings 7
- Setting Regeneration Cycle Times..... 10
- Installer Display Settings 11
- Diagnostics..... 13

EE Front Cover and Drive Assembly

Drawing No.	Order No.	Description	Quantity
1	V3175EE-01	WS1EE FRONT COVER ASSEMBLY	1
2	V3107-01	WS1 MOTOR	1
3	V3106-01	WS1 DRIVE BRACKET & SPRING CLIP	1
4	V3408EE-02BOARD	WS1THRU2L/2 EEPCBRD MAV/ALT REPL	1
5	V3110	WS1 DRIVE GEAR 12X36	3
6	V3109	WS1 DRIVE GEAR COVER	1
Not Shown	V3186	WS1 AC ADAPTER 110V-12V	1
	V3186-01	WS1 AC ADAPTER CORD ONLY	
Not Shown	V3178	WS1 Drive Back Plate	1

Refer to Control Valve Service Manual for other drawings and part numbers.

AC Adapter	U.S.	International
Supply Voltage	120 V AC	230V AC
Supply Frequency	60 Hz	50 Hz
Output Voltage	12 V AC	12 V AC
Output Current	500 mA	500 mA

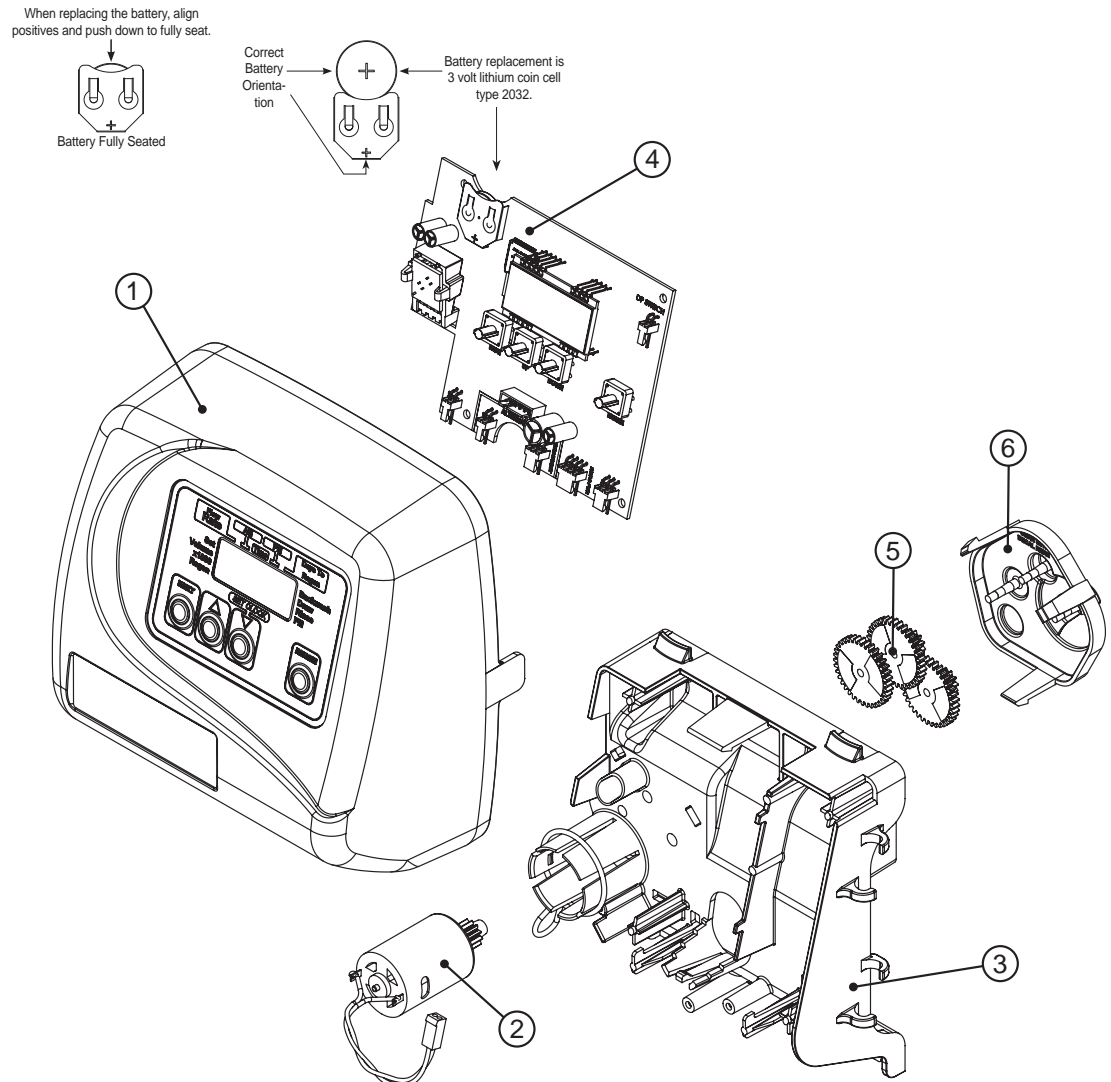

Regeneration and Error Screens

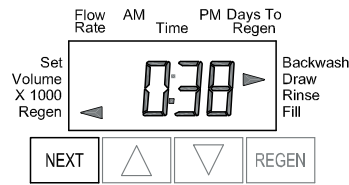

Regen Screen

Displays the time remaining in the current cycle. Pressing REGEN advances to the next cycle.

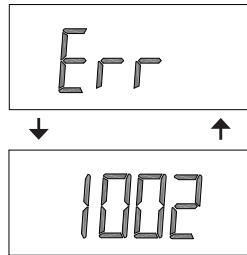

Error Screen

Alternated flashing Err and error code every 3 seconds. Clear by disconnecting the power supply at the PC board and reconnecting, or press the NEXT and REGEN buttons simultaneously for 3 seconds.

Button Operation and Function



Scrolls to the next display.

Pressing once and releasing will schedule a regeneration at the preset delayed regeneration time.

Pressing again and releasing will cancel the regeneration.

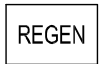

Pressing and holding for 3 seconds will initiate an immediate regeneration

Pressing while in regeneration will advance to the next cycle.

Pressing in the program levels will go backwards to the previous screen



Changes variable being displayed.



Key sequence to lock and unlock program settings.



Holding for 3 seconds initiates a control reset. The software version is displayed and the piston returns to the home/service position, resynchronizing the valve.

Regeneration Cycles and Times

Cycle	Range of times (min.)
1. Backwash 1 st (upflow)	1 - 20 or OFF
2. Regenerant Draw/Slow Rinse (downflow)	1 - 99 or OFF
3. Backwash 2 nd (upflow)	1 - 20 or OFF
4. Fast Rinse (downflow)	1 - 20 or OFF
5. Regenerant Refill (with treated water)	0.1 - 99.9 or OFF
6. Service (downflow)	

The user can initiate manual regeneration. The user has the option to request the manual regeneration at the delayed regeneration time or to have the regeneration occur immediately:

1. Pressing and releasing the REGEN button. “◀” will flash towards Regen on the display and the regeneration will occur at the delayed regeneration time. The user can cancel the request by pressing and releasing the REGEN button.
2. Pressing and holding the REGEN button for approximately 3 seconds will immediately start the regeneration. The user cannot cancel this request, except by resetting the control by pressing NEXT and REGEN buttons simultaneously for 3 seconds.

User Displays

General Operation

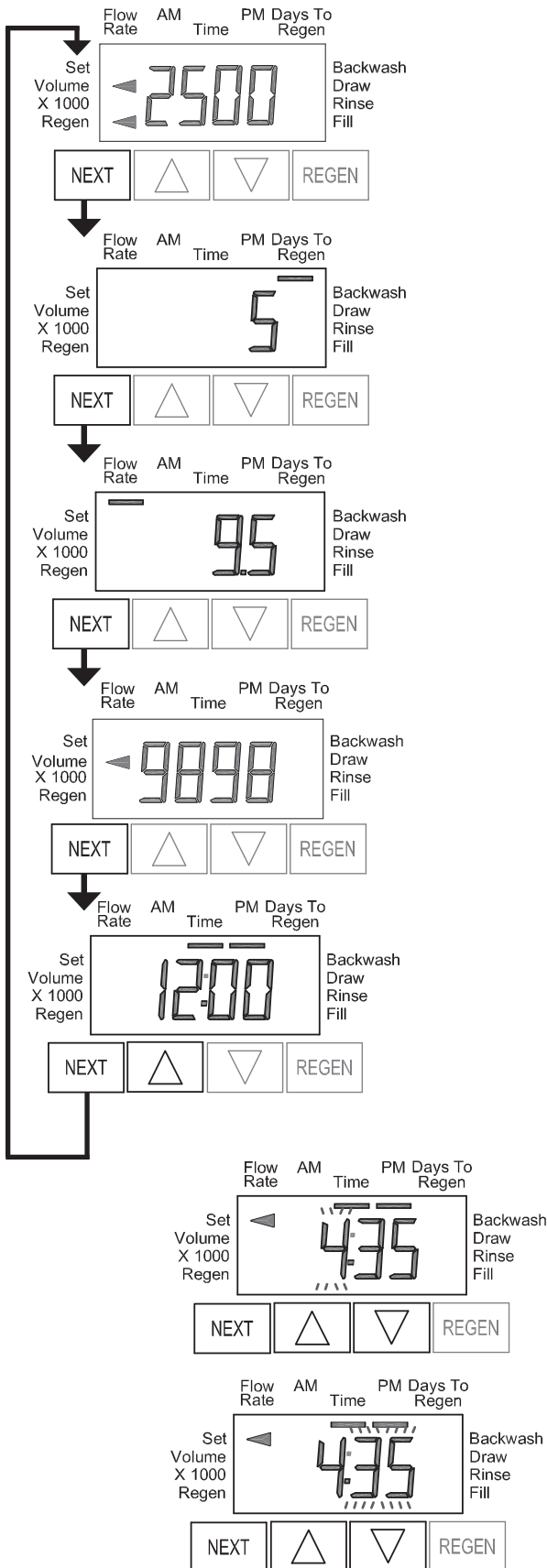

When the system is operating, one of five displays may be shown. Pressing NEXT will alternate between the displays shown below.

User 1

Typical user display. If volume is selected in Configuration Settings Step 3CS, shows volume remaining to regeneration. If volume is not selected in Configuration Settings Step 3CS, this screen will not be shown. If a meter is not used this display will not change.

User 2

Displays number of days to next regeneration.

User 3

Displays flow rate in gallons per minute. If a meter is not used this display will be shown but 0 will be displayed. This screen will not be shown if 7 day or 28 day is selected in Configuration Settings Step 3CS.

User 4

Displays total flow in gallons since last reset. If a meter is not used this display will be shown but 0 will be displayed. This screen will not be shown if 7 day or 28 day is selected in Configuration Settings Step 3CS.

PRESS THE DOWN ▼ ARROW FOR 3 SECONDS TO RESET TO 0.

User 5

Shows current time.

Setting Time of Day

Push NEXT button until time of day screen is displayed. Press and hold the ▲ or ▼ arrow until the SET indicator is displayed, and the hour flashes. Press the ▲ or ▼ button until the correct hour is displayed.

Then press the NEXT button. The minutes will flash. Press the ▲ or ▼ arrow until the correct minute is displayed.

Press the NEXT button to return to the Display Screens. Time of day should only need to be set after power outages lasting more than 8 hours, if the battery has been depleted and a power outage occurs, or when daylight saving time begins or ends. If a power outage lasting more than 8 hours occurs, the time of day will flash on and off which indicates the time of day should be reset. If a power outage lasts less than 8 hours and the time of day flashes on and off, the time of day should be reset and the battery replaced.

Configuration Settings

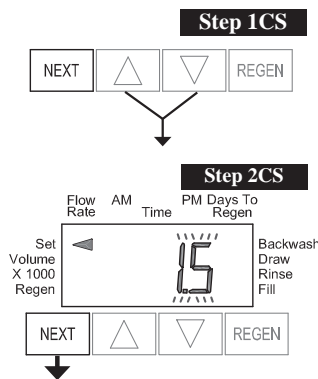

Step 1CS – Press ▲ and ▼ buttons simultaneously for 5 seconds and release. If screen in Step 2CS does not appear, the lock on the valve is activated. To unlock press ▼, NEXT, REGEN, ▲ in sequence, then press ▲ and ▼ buttons simultaneously for 5 seconds and release.

Step 2CS – Choose 1.0 for 1”, 1.25 for 1.25”, 1.5 for 1.5”, 2.0L for 2L, 2.0 for 2” valve ¹. Press NEXT to go to Step 3CS. Press REGEN to exit Configuration Settings.

Note: When using the WS2 valve, if “2L” is set instead on “2.0” for valve type, when the valve is in regeneration and the piston drives to the “Draw” cycle the piston will stall and generate a 1002 error code. Clear error code by pressing “NEXT” and “REGEN” simultaneously until the valve resets, then re-program to proper valve type setting.

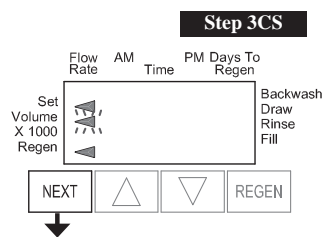

Step 3CS – Press the ▲ or ▼ buttons to select one of the following:

- If Volume (gallons) is selected the regeneration will occur after the specific volume has been used or on the day override (if selected) whichever comes first.
- If 28/Volume (gallons) is selected the regeneration will occur on the day (1 through 28) selected in Installer Display Settings. If a meter is not used the total flow and flow rate user displays and the volume display in Diagnostics will be shown as 0.
- If 7/Volume (gallons) is selected the regeneration will occur on the selected day(s) of the week (see instructions contained in Installer Display Settings). If a meter is not used the total flow and flow rate user displays and the volume display in Diagnostics will be shown as 0.
- If 28 is selected the regeneration will occur on the day (1 through 28) selected in Installer Display Settings. The total flow and flow rate user displays and the volume display in Diagnostics will not be shown even if a meter is used.
- If 7 is selected the regeneration will occur on the selected day(s) of the week (see instructions contained in Installer Display Settings). The total flow and flow rate user displays and the volume display in Diagnostics will not be shown even if a meter is used.

Press NEXT to go to Step 4CS. Press REGEN to return to previous step.

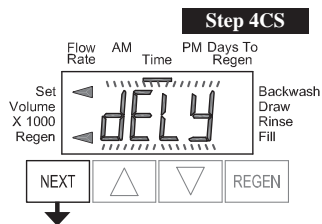

Step 4CS – Press the ▲ or ▼ buttons to select to regenerate immediately on 0 or at delayed time.

Immediately on 0 can only be selected if Volume (gallons) was selected in step 3CS and a meter must be installed. Delay is the only option for the other Step 3CS selections. Press NEXT to go to Step 5CS. Press REGEN to return to previous step.

¹ When using the WS2 control valve, the circuit board software must have meter selection choices of 2.0 and 2.0L. The WS2 valve must be set for the 2.0 meter selection during programming. If the software version does not have both the 2.0 and 2.0L selections, consult your equipment supplier for a replacement circuit board. When using the WS2L valve with older version software that does not have both 2.0 and 2.0L selection choices, the valve must be set to 2.0 during programming. If a WS2L valve is being used with newer version software that has both 2.0 and 2.0L selection choices, the valve must be set to 2.0L during programming.

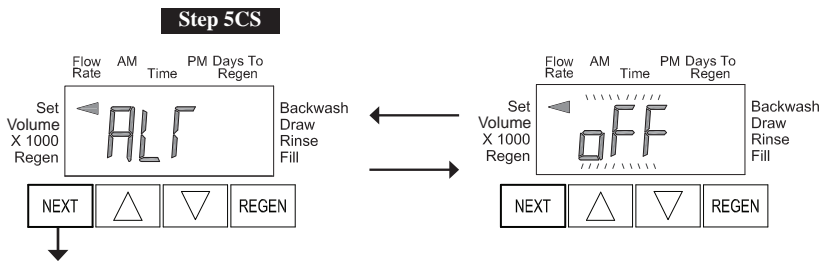

Step 5CS -- Allows selection of one of the following using the ▲ or ▼ buttons:

- the Control Valve to have no hard water bypass;
- the Control Valve to act as an alternator; or
- the Control Valve to have a separate source during the regeneration cycle.

Select OFF when none of these features are used.

Only use Clack No Hard Water Bypass Valves or Clack Motorized Alternating Valves (MAV) with these

selections. Clack No Hard Water Bypass Valves (1" or 1.25" V3070FF or V3070FM) are not designed to be used with the alternator or separate source functions. The V3063 and V3063BSPT motorized alternating valves are not designed to be used as a no hard water bypass or separate source inlet if the pressure differential is more than 60 psi.

Configuring the Control Valve for No Hard Water Bypass Operation:

Select nHbP for control operation. For no hard water bypass operation the three wire connector is not used.

Selection requires that a connection to MAV or a Clack No Hard Water Bypass Valve is made to the two pin connector labeled ALTERNATOR DRIVE located on the printed circuit board. If using a MAV, the A port of the MAV must be plugged and the valve outlet connected to the B port. When set to nHbP the MAV will be driven closed before the first regeneration cycle that is not FILL or SOFTENING or FILTERING, and be driven open after the last regeneration cycle that is not FILL.

NOTE: If the control valve enters into an error state during regeneration mode, the no hard water bypass valve will remain in its current state until the error is corrected and reset.

Configuring the Control Valve for Separate Source Operation:

Select nHbP for control operation. For separate source operation the three wire connector is not used.

Selection requires that a connection to a Clack Motorized Alternator Valve (MAV) is made to the two pin connector labeled ALTERNATOR DRIVE located on the printed circuit board. The C port of the MAV must be connected to the valve inlet and the A port connected to the separate source used during regeneration. The B port must be connected to the feed water supply.

When set to nHbP the MAV will be driven closed before the first regeneration cycle, and be driven open after the last regeneration cycle.

NOTE: If the control valve enters into an error state during regeneration mode, the MAV will remain in its current state until the error is corrected and reset.

Selecting the Control Valve to act as an alternator:

Prior to starting the programming steps, connect the interconnect cable to each control valve board's three pin connector labeled "INTERCONNECT". Also connect the meter cord to either control valve to the three pin connector labeled "METER".			
		Valve Programming Steps	
Configuration Settings	Step 3CS	Select Volume	Set Volume
Configuration Settings	Step 4CS	Set regeneration time option to "On O".	Set regeneration time option to "On O".
Configuration Settings	Step5CS	Set to ALTA Connect ALTA valve to the MAV's A port and connect the MAV's two pin wire connector to the two pin connector labeled "DRIVE" on the ALTA valve	Set to ALTb Connect ALTb valve to the MAV's B port. No connections between the ALTB valve and the MAV are made.
Installer Display Setting	Step 2I	Enter the Volumetric Capacity for the System	Enter the Volumetric Capacity for the System (the same as Valve A)
Installer Display Setting	Step 3I	Set Day Over ride to "oFF"	Set Day Over ride to "oFF"

NOTE: If the control valve is in an error state during regeneration mode the MAV will close the B port and keep open the A port until the error is corrected and reset.

For Clack Corporation alternator systems using the WS1, WS1.25, WS1.5 and WS2L valves the stand by tank will be periodically brought on line for a short time to keep its bed fresh. The logic is that once a tank is in standby and the time has passed either 6 AM or 6 PM (18:00) at the next and all subsequent 6 AM and 6 PM times the stand by tank will be brought on line until 10 gallons (37.8 liters) has passed through it. It will then be placed back on standby.

For Clack Corporation alternator systems using the WS2 valve, when NEXT is pressed after selecting ALTA or ALTb, a display will allow the user to set the amount of pre-service rinse time for the stand by tank just prior to returning to service.

Press NEXT to go to Step 6CS. Press REGEN to return to previous step.

Step 6CS

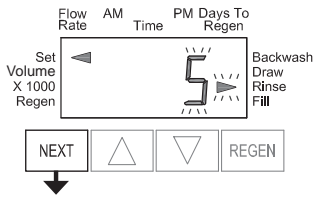

Step 6CS – Set duration of the special rinse cycle to be performed prior to a valve returning to Service. Selectable from 1 - 20 minutes or OFF. Only viewed if 2.0 is set in 2CS, and ALTA or ALTb is set in 5CS.

Press NEXT to go to Step 7CS. Press REGEN to return to previous step.

Step 7CS

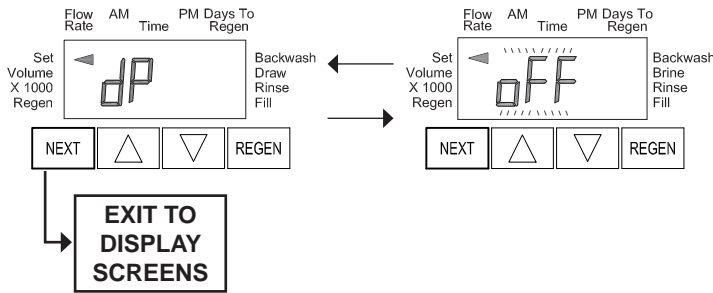

Step 7CS

Selecting the use of an outside signal to initiate a regeneration: Selection only matters if a connection is made to the two pin connector labeled DP SWITCH located on the printed circuit board. Following is an explanation of the options:

- oFF - Feature not used.
 - on0 - If the dP switch is closed for an accumulative time of 2 minutes a regeneration will occur immediately.
 - dELy - If the dP switch is closed for an accumulative time of 2 minutes a regeneration will occur at the scheduled regeneration time.
 - HoLd - If the dP switch is closed a regeneration will be prevented from occurring.
- Not viewed if Step 5CS is set to ALTA or ALTb.

Press NEXT to exit Configuration Settings. Press REGEN to return to previous step.

Setting Regeneration Cycle Times

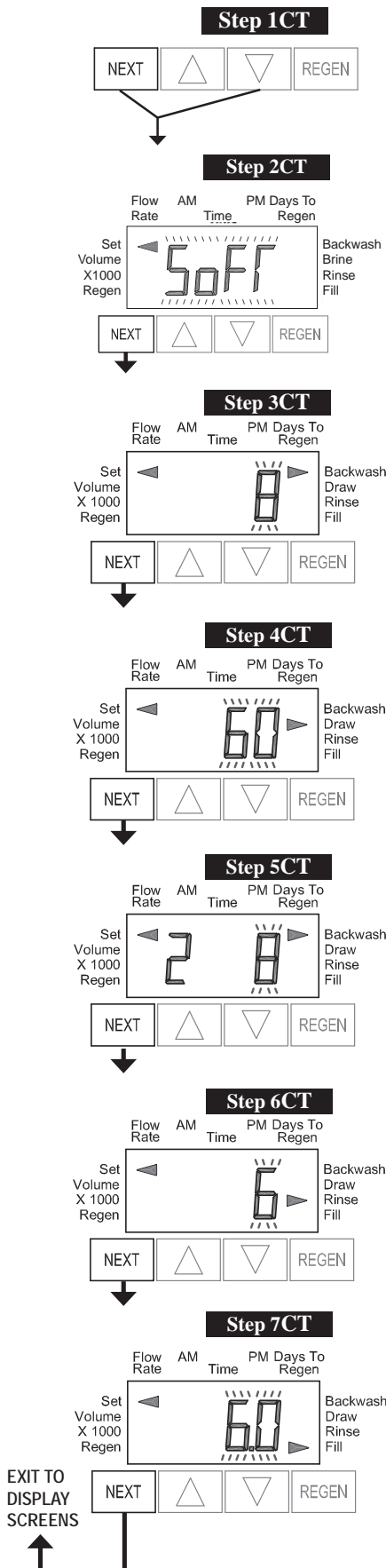

Step 1CT - Press NEXT and ▼ simultaneously for 5 seconds and release. If screen in Step 2CT does not appear, the lock on the valve is activated. To unlock press ▼, NEXT, REGEN, ▲ in sequence, then press NEXT and ▼ simultaneously for 5 seconds and release.

Step 2CT - Select between SOFTENING or FILTERING. When set to FLTr, 7CT is not set to off, and 2CS is set to 1.0, a fixed 30 second Backwash is automatically added to the regen cycle program after Rinse 6CT. The status display for this extra backwash will appear as just another cycle step in sequence. Press NEXT to go to Step 3CT. Press REGEN to exit Regeneration Cycle Times.

Step 3CT - Adjust the length of the backwash from 1-20 minutes or OFF using the ▲ or ▼ buttons.

Press NEXT to go to Step 4CT. Press REGEN to return to previous step.

Step 4CT - Adjust the length of the regenerant draw from 1-99 minutes or OFF using the ▲ or ▼ buttons.

Press NEXT to go to Step 5CT. Press REGEN to return to previous step.

Step 5CT - Adjust the length of the second backwash from 1-20 minutes or OFF using the ▲ or ▼ buttons.

Press NEXT to go to Step 6CT. Press REGEN to return to previous step.

Step 6CT - Adjust the length of rinse from 1-20 minutes or OFF using the ▲ or ▼ buttons.

Press NEXT to go to Step 7CT. Press REGEN to return to previous step.

Step 7CT - Adjust the length of fill from 0.1-99.0 minutes or OFF. WS2 valves are shipped from the factory with a refill flow control of 2.2 gpm (8.3 lpm). All other control valves are shipped from the factory with a refill flow control of 0.5 gpm (1.9 lpm).

Press NEXT to exit Regeneration Cycle Times. Press REGEN to return to previous step.

Installer Display Settings

One of three sets of displays will be shown depending on what was selected in Configuration Settings Step 3CS.

Volume (Gallons) selected in Configuration Settings Step 3CS

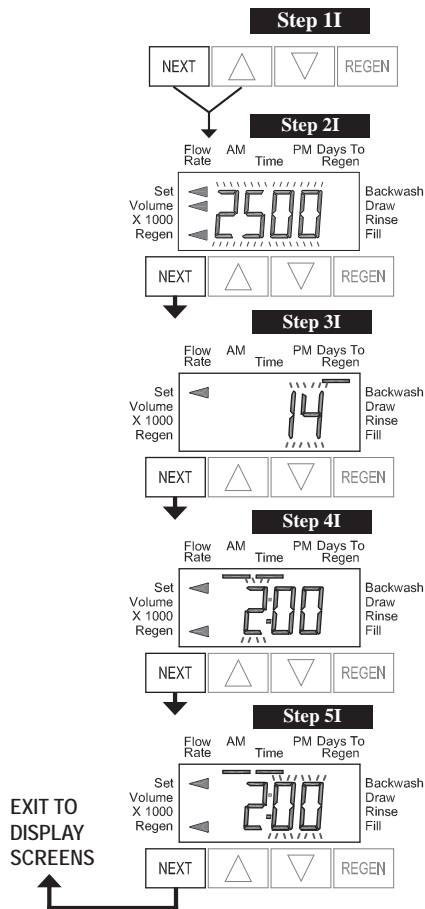

Step 1I - To enter Installer Display press the NEXT and ▲ buttons simultaneously for 5 seconds and release.

Step 2I - Volumetric capacity in gallons to regeneration. Press NEXT to go to Step 3I. Press REGEN to exit Installer Display.

Step 3I - Adjust day override from 1 - 28 or OFF. Press NEXT to go to Step 4I. Press REGEN to return to previous step.

Step 4I - Use ▲ or ▼ buttons to set the regen hour. Press NEXT to go to Step 5I. Press REGEN to return to the previous step.

Step 5I - Use ▲ or ▼ buttons to set the regen minutes. Press NEXT to exit Installer Display. Press REGEN to return to previous step.

28 Day or 28/Volume (Gallons) selected in Configuration Settings Step 3CS

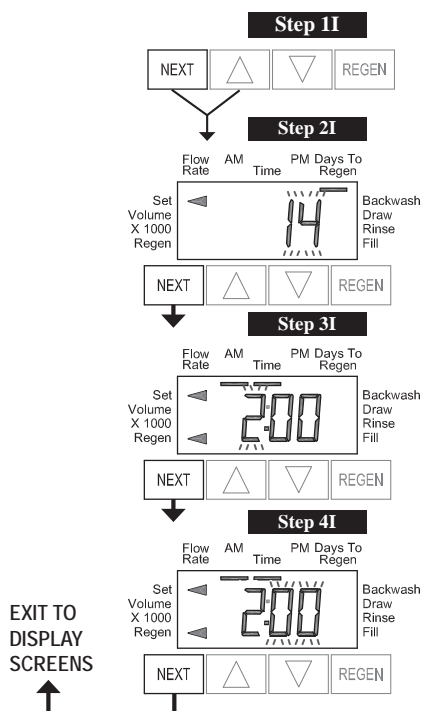

Step 1I - To enter Installer Display press the NEXT and ▲ buttons simultaneously for five seconds and release.

Step 2I - Adjust days from 1 - 28. Press NEXT to go to Step 3I. Press REGEN to exit Installer Display.

Step 3I - Use ▲ or ▼ buttons to set time of the regen hour. Press NEXT to go to Step 4I. Press REGEN to return to previous step.

Step 4I - Use ▲ and ▼ buttons to set the regen minutes. Press NEXT to exit Installer Display. Press REGEN to return to previous step.

7 Day or 7/Volume (Gallons) selected in Configuration Settings Step 3CS

Step 1I



Step 1I - To enter Installer Display press the NEXT and ▲ buttons simultaneously for 5 seconds and release.

Step 2I



Step 2I - Use ▲ or ▼ buttons to set the current day of the week.

Default = 2 (Monday)

- 1 = SUNDAY
- 2 = MONDAY
- 3 = TUESDAY
- 4 = WEDNESDAY
- 5 = THURSDAY
- 6 = FRIDAY
- 7 = SATURDAY

Press NEXT to go to Step 3I. Press REGEN to exit Installer Display.

Step 3I

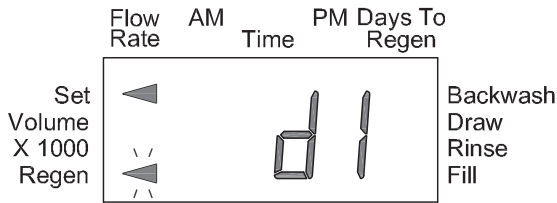

Step 3I - Scroll through days 1 to 7 using the NEXT button. Use the ▲ or ▼ buttons to turn regen on or off for each individual day (regen indicator on means regeneration will happen). After completing the 7th day, press NEXT to go to Step 4I. Press REGEN to go to previous display.

Step 4I

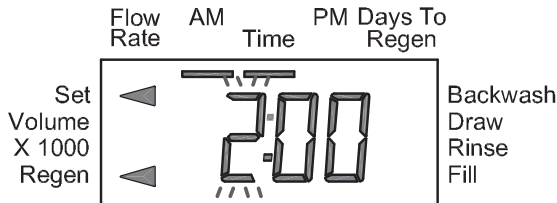

Step 4I - Use the ▲ or ▼ buttons to set the regen hour. Press NEXT to go to Step 5I. Press REGEN to go to previous display.

Step 5I

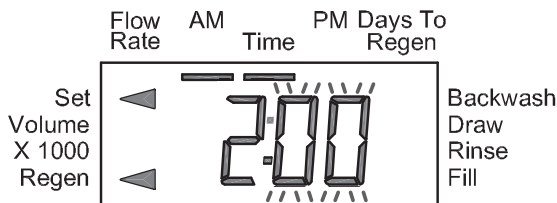

Step 5I - Use the ▲ or ▼ buttons to set the regen minutes. Press NEXT to exit Installer Display. Press REGEN to return to previous display.

EXIT TO
DISPLAY
SCREENS



Diagnostics

Step 1D

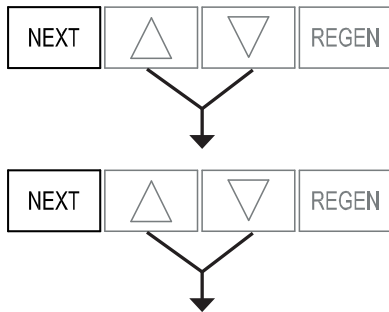

Step 2D

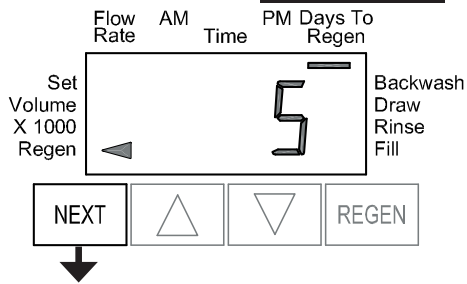

Step 3D

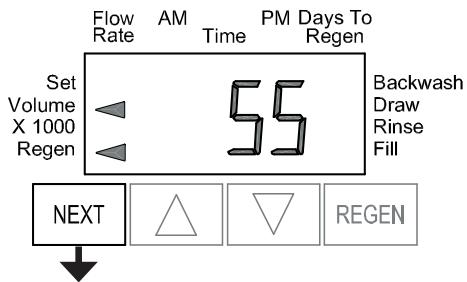

Step 4D

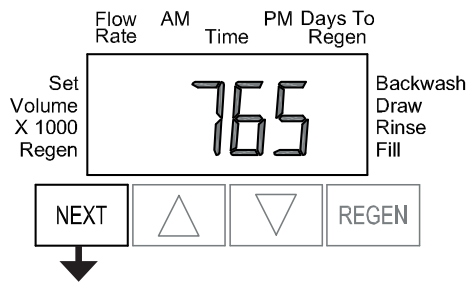

Step 5D

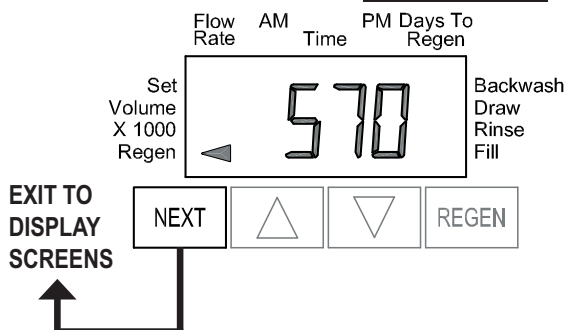

Step 1D - Press ▲ and ▼ buttons simultaneously for 5 seconds and release. Then press ▲ and ▼ buttons simultaneously for 2 seconds and release. If screen in Step 2D does not appear the lock on the valve is activated. To unlock press ▼, NEXT, REGEN, ▲ in sequence, then press ▲ and ▼ buttons simultaneously for 5 seconds and release. Then press ▲ and ▼ buttons simultaneously for 2 seconds and release.

Step 2D - Display shows the number of days since a regeneration last occurred. Press NEXT to go to Step 3D. Press REGEN to exit Diagnostics.

Step 3D - Display shows the volume of water treated in gallons treated since the last regeneration. If Volume (gallons), 28/Volume (gallons), or 7/Volume (gallons) was selected in Step 3CS and no meter is installed this display will read 0. Press NEXT to go to Step 4D. Press REGEN to return to previous step.

Step 4D - Display shows the days in service since start up. Press NEXT to go to Step 5D. Press REGEN to return to previous step.

Step 5D - Display shows the total number of regeneration cycles since start up. Press NEXT to exit Diagnostics. Press REGEN to return to previous step.

Revision History:

10/13/2008

PAGES 11-13:

Updated Motorized Alternating Valve and No Hard Water Bypass instructions.

1/5/2009

PAGES 9:

Updated the instructions for Step 7CT.

3/16/2009

PAGES 10 & 11:

Revised Step 2CS.

Revised Step 5CS.

3/30/2009

Page order changed after page 6.

PAGE 7:

Added note to Step 2CS.

4/1/2009

PAGE 8:

Corrected display header in Step 5CS.

PAGE 9:

Corrected display header in Step 6CS.